

RHT4550 450W HEDGE TRIMMER IN2

5133002793 - RHT4550 450W - 4000462005





4000462004
4000462005
4000462006
4000462007

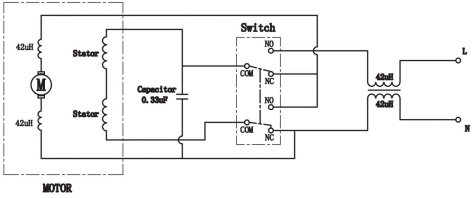
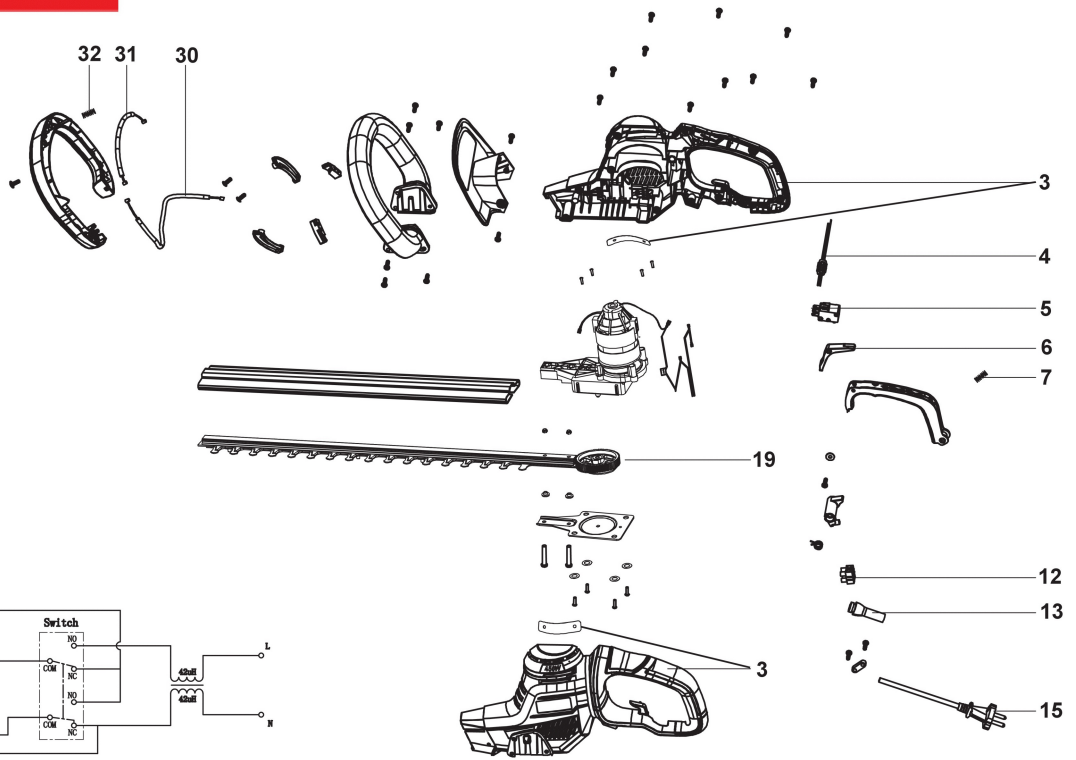

Position	Quantity	Description	Part number	EAN
1003	1	HOUSING	5131040171	4058546052331
1004	1	ELECTRONIC	5131040173	4058546052355
1005	1	SWITCH	5131040174	4058546052362
1006	1	CLAMP	5131040175	4058546052379
1007	1	SPRING	5131040176	4058546052386
1012	1	CONNECTOR	5131034868	4058546144135
1013	1	PROTECTION SLEEVE	5131040177	4058546052393
1015	1	POWER CORD	5131040179	4058546052416
1019	1	DOUBLE-SIDED BLADE	5131040181	4058546052430
1030	1	WIRE	5131040182	4058546052447
1031	1	WIRE	5131040183	4058546052454
1032	1	SPRING	5131040184	4058546052461